

RØDE[®]
MICROPHONES

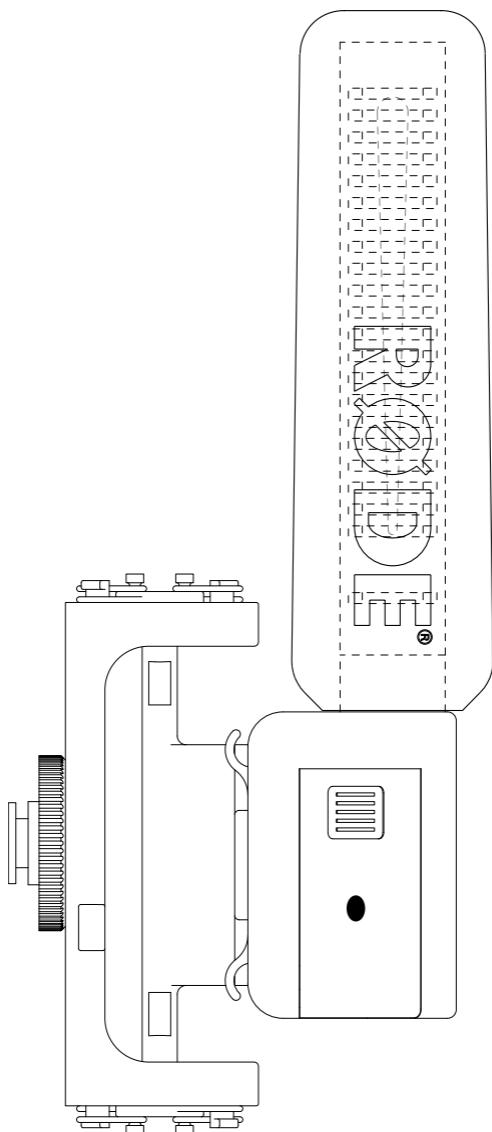

VideoMic

Instruction Manual



CE (EMC, LVD)



RØDE VideoMic

Thank you for investing in the **RØDE** VideoMic.

Those of you who are first time **RØDE** customers, may be interested to know that **RØDE** is one of the largest and most respected professional microphone companies in the world. Our studio microphones are the 'tone' behind some of the biggest hits of the last decade, and our award winning live performance microphones are on tour throughout the world.

The VideoMic is a very special product. Like many great inventions, it is the result of a need that was not being met. I bought a high quality MiniDV camera, and went looking for a shotgun mic. The choices were either totally useless low cost rubbish, or mics not designed for MiniDV cameras that cost a fortune.

I was amazed that no one offered a quality product that worked and was affordable. This made me decide to design and build the definitive video microphone.

I wanted a microphone that would provide the same level of sound quality and low noise specifications as high cost professional models, and be easy to use, and mount. The **RØDE** VideoMic delivers on that aim!

How can **RØDE** achieve this when others can't? It is simple.

RØDE spends millions of dollars on R&D and automated machinery. When you invest in high volume production technologies, the costs drop dramatically. We pass on these savings to our customers. We have been doing this with our studio microphones for the last 14 years, and continue to win international awards for performance and quality.

Please take the time to read this manual so that you can get the best out of your microphone.

If you have any questions or comments, you can log onto our web site: www.rodemic.com/videomic where there are answers to frequently asked questions as well as our contact details.



Peter Freedman
Sydney, Australia

Specifications

Acoustic Principle:

Line plus Gradient

Directional Pattern:

Super-Cardioid.

Frequency range:

40 Hz ~ 20 000 Hz selectable High Pass Filter (HPF) @ 80 HZ 12 dB/octave.

Output Impedance:

200 Ω

Signal/Noise ratio DIN/IEC 651:

74 dB

(1 kHz rel. 1 Pa; per IEC651, IEC268-15)

Equivalent Noise:

20 dBA SPL (per IEC651, IEC268-15)

Maximum SPL:

134 dB (@ 1% THD into 1KΩ)

Sensitivity at 1 kHz into 1 kΩ:

-38 dB re 1Volt/Pascal

Dynamic Range - DIN/IEC 651:

114 dB (per IEC651, IEC268-15)

Power (Supply voltage):

9V Alkaline Battery, Current 5 mA

Battery Life:

>100 hours

Output Connection:

3.5 mm stereo jack plug

Weight - no battery:

110 grm (3.88 oz)

Features

- Studio recording quality.
- Rugged ABS construction.
- 9V battery operation.
- Custom designed integral 'wind' screen.
- Condenser microphone.
- Low noise circuitry.
- Low handling noise.
- Integral hot shoe mount & zip pouch.
- Designed & manufactured in Australia.
- Full 2 year guarantee.

Specifications cont.

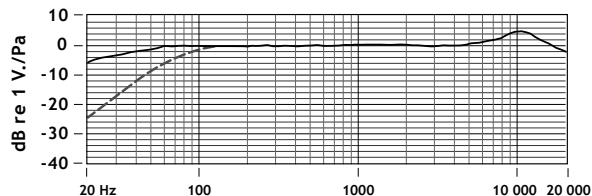
Frequency range:40 Hz ~ 20 000 Hz selectable (HPF)
@ 80 Hz 12 dB/octave.**VideoMic Polar Pattern:**

Super Cardioid - 250 Hz

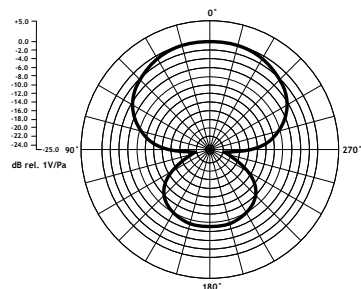
**VideoMic Polar Pattern:**

Super Cardioid - 1 KHz

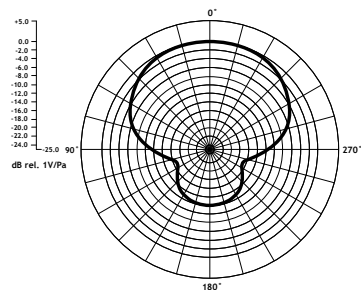
**VideoMic Polar Pattern:**

Super Cardioid - 4 KHz

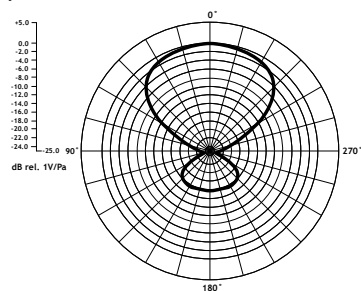

Battery Installation

- 1) The VideoMic operates on a standard 9V battery (ANSI:1604A or IEC:6LR61). We recommend you use either Alkaline or Lithium batteries for the longest continuous operating time.
- 2) The VideoMic will run continuously for over 100 hrs. with a good quality Alkaline battery. It is however important to understand that battery performance can vary dramatically with ambient temperature and of course shelf life. Actual operation times will vary, and we suggest you always carry a spare battery.

If the application is critical and where there is no opportunity to 're-shoot', we suggest that you use a fresh battery.
- 3) To install the battery, simply place your thumb on the ribbed section of the cover, in front of the gold circle (fig. 1).



fig. 1



fig. 2

Press down gently and slide back the cover till it is fully removed (fig. 2).

Insert the battery with the “+” Positive (circular) terminal to the top as shown in (fig. 3). You will find that you cannot reverse the battery, as the compartment won't allow this.



fig. 3

Once you have installed the battery, slide the cover back into position and you are ready to fasten the mic onto the camera.

Mounting Your VideoMic

- 4) The VideoMic incorporates a standard Hot-shoe adaptor on the underside of the integral suspension shock mount (fig. 4). Designed to reduce camera borne motor and handling noise, the shock mount has a 3/8” x 16 and a 1/4” x 20 threaded insert for mounting on tripods and poles.



fig. 4

You will find older model and low cost

cameras produce more motor noise, which the VideoMic can pick up. If so, switch on the High Pass Filter (HPF) to reduce this (fig. 8a).

You could also notice that your camera's inbuilt microphone may not pick up this noise and wonder why. On-board mics are for general-purpose use, and designed to do a basic job. They can cancel out certain sounds such as motor noise at the expense of tone and directional characteristics.

The very latest cameras incorporate low noise/vibration motors, making them relatively silent.

- 5) Before sliding the Hot-shoe into place, turn the knurled tightening ring anti clockwise which will make sliding the Hot-shoe into place much easier (fig. 5).



fig. 5

Now turn the knurled ring in a clockwise direction, gently tightening it so the VideoMic is seated firmly in place. You will notice the VideoMic may seem slightly loose in its mount. This is due to the shock mount system and is not a fault.



fig. 6

The VideoMic has eight cable clips to eliminate noise transmission and secure it in place once connected (fig. 6).

Mounting Your VideoMic cont.

- 6) The VideoMic delivers a mic level signal to the video camera via a stereo mini jack audio lead.



fig. 7

The mini jack should be connected to the camera via the camera's "Audio-In" socket (fig. 7), - refer to your video camera user manual.

VideoMic Controls

- 7) Now that you have the VideoMic securely fastened to your camera and the audio output lead connected, you can switch the mic on.

There is a three way switch located on the end of the mic body (fig. 8 & 8a): **Off**, **On** and  - High Pass Filter or (HPF). The HPF is a low frequency cutoff setting, which you can use to remove rumble or other low frequency noise while recording. It will effect the tone slightly but in some situations it is required.

A power indicator LED flashes RED for 0.25 sec. when the mic is first turned on. This changes to GREEN indicating the battery has adequate charge. When the battery runs low, the LED will change back to RED and you should change the battery for a fresh one. The mic will work for approximately 1 hr. once the RED indicator is lit, however with reduced performance.

VideoMic Controls cont.

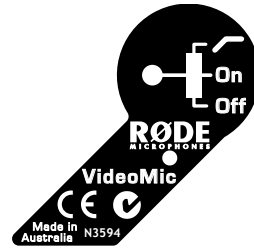

fig. 8 - VideoMic Controls

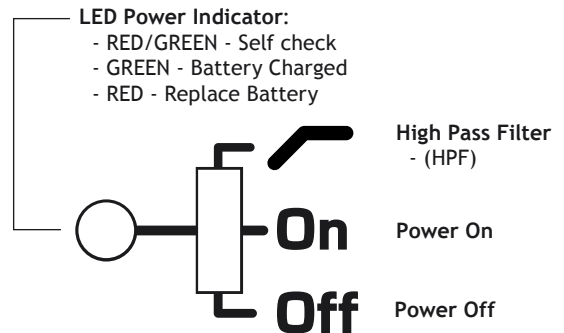

fig. 8a - Power Controls

- 8) It is now time to set the camera's audio level. To ensure the optimum signal you will need to set the VU meter on the camera to read around "3/4" or "75%" on the sound peaks (most cameras will allow you to access this setting through the camera menu). You should try and set the level using the sound source you will be recording, or a sound source of similar level before starting to record or you could distort the input if the level has been set too high. We suggest you read your camera manual, which should cover this topic.

The Video Mic has been optimized for high rejection of radio frequency interference, but we suggest you keep all transmitters, cell phones, pagers etc. at least 2m away to reduce the possibility of interference ruining your recordings.

VideoMic Windshield

- 9) The VideoMic comes with a foam windshield; held in place with Velcro. There is no need to remove it, but I know you want to have a look. Go ahead, but be careful not to rip it.

The windshield should be left on at all times as even the slightest breeze can cause sound interference. When shooting outside in heavy winds you may need to purchase a more specialised wind shield.

RODE has a full line of accessories such as windshields, boom poles, cable extenders and pistol grips which will be available in early 2005. Please visit our web site www.rodemic.com/videomic for further details.

General Operation

- 10) While it may sound like a contradiction, shotgun mics are not designed for long distance pick up. I have heard people ask, "How far away can this mic pickup sound?". Of course you can boost the gain level on your camera and you will hear more defined sounds over a longer distance than with conventional microphones.

Long distance pick up microphones include parabolic reflector systems and more recently adaptive arrays using multiple capsules and Digital Signal Processing (DSP) technologies. Shotgun microphones have a narrow pick-up angle or polar response, and so can be used to great effect with cameras for news gathering, weddings or sporting events. The VideoMic can be used in any situation where you want to listen to what's in the shot, not what's at the side or out of view.

- 11) The best way to get optimum results with the Videomic is to use it so you become more familiar with its sound and pick up characteristics.

General Operation cont.

The VideoMic is made from high-strength ABS, ensuring impact resistance and a longer life. However care must be taken not to get the VideoMic wet. Treat the mic the way you treat your camera and you should have many years of reliable service.

Warranty Service

The **RØDE** VideoMic is warranted for two years from the date of purchase and the warranty card should be used to record and register that purchase.

The warranty covers parts and labour that may be required to repair the microphone during the warranty period.

The warranty excludes defects caused by normal wear and tear, modification, shipping damage, or failure to use the microphone as per the instruction guide.

If you experience any problems or have any questions regarding your **RØDE** microphone, first, contact the dealer who sold it to you. If the microphone requires factory authorized service, that dealer will organise return.

We have an extensive distributor/dealer network but if you have difficulty getting the advice or assistance you require, do not hesitate to contact us directly or contact your local distributor.

Contact Details

International:

RØDE Microphones

ABN 91 000 576 483

107 Carnarvon Street
Silverwater N.S.W
2128 Australia.

P.O. Box 6685
Silverwater N.S.W
2128 Australia.

Ph: 61 2 9648-5855

Fax: 61 2 9648-2455

USA:

RØDE Microphones

P.O. Box 3279
Torrance, CA 90510-3279

Ph: 877 328 7456 (Toll free within the U.S.)

Ph: 310-328-7456

Fax: 310-328-7180

Website:

www.rodemic.com

RØDE[®]
MICROPHONES

