

Understanding CinéWave The New Wave in Digital Cinema



by
Laurin Herr
Forest Key
Marshall Johnson
Lee Croft

Version 1.0.1
January 16, 2001

<http://www.pinnaclesys.com>



Introduction and Overview **1**
 CinéWave Feature Overview 1
 The Memory-centric Advantage 2

CinéWave Bandwidth **3**
 Programmable Pixel Resolutions 3
 Programmable Frame Rates 4
 Interlace and Progressive Scanning 4
 Color Space Alternatives 4
 Digital Video Bandwidth 8
 Digital Video Sampling 9

Quality Theory Applied in a Real-World Workflow **11**
 10-bit versus 8-bit 12

TARGA Ciné QuickTime Codec **14**
 Embedded Alpha Channels 15
 Previewing With CinéWave from Within Software Applications 15
 Uncompressed Codec For Best Quality 16
 CinéOffline 19
 Realtime Effects with CinéWave 20

Digital Tether **23**
 Realtime Simultaneous SD & HD Output 24
 CinéWave Workgroups 25
 SD Today, HD Tomorrow 26

HD in Use Today **28**
 Traditional Uses for HD 28
 Emerging Markets for HD 28

Introduction and Overview

CinéWave is a next generation digital media authoring system—QuickTime native, with superb quality uncompressed SD & HD video. The power of the system is achieved through a combination of scalable hardware and software working together to deliver amazing price/performance, flexibility and image quality.

CinéWave implements an elegant architecture for next generation digital content creation, with many technical advantages that can practically benefit professional users. CinéWave was designed from the start to make it possible, at a reasonable cost, to use the same system, same hardware and same applications seamlessly across a widening array of “common” formats, including both 601 standard definition (SD) video and leading high definition (HD) formats at the highest quality, with flexible workflow alternatives. As the demand for all types of visual content increases and distribution channels diversify, production and post-production companies must control their costs without sacrificing their creativity, productivity or the ultimate quality of their commercial product. CinéWave is the new way to solve this puzzle more simply than ever before.

If you find you have additional questions after reading this paper, more information about CinéWave can be obtained through one of the many public CinéWave lists and forums on the Internet, by contacting your local Pinnacle Systems Dealer, or by contacting Pinnacle Systems Technical support. For information on how to participate in these forums, or to contact Technical Support, please visit our website at <http://www.pinnaclesys.com>.

CINÉWAVE FEATURE OVERVIEW

What is CinéWave, and what does it offer the end user?

- Complete professional non-linear editing and effects software solution with Final Cut Pro and Commotion Pro, optimized for speed on the G4 Velocity Engine, including support for multi-processor G4 systems.
- High definition video (HD) and standard definition video (SD) production capabilities at a breakthrough price with scalable uncompressed image quality and flexible I/O options.
- Complete QuickTime native software, including Pinnacle’s TARGA Ciné software codecs in both RGB and YUV¹ color space, 8- or 16-bits, offering the greatest flexibility for all workflows at the highest quality available.
- Powerful QuickTime native hardware. Pinnacle’s TARGA Ciné Engine with the HUB-3 video processor and 128 MB memory-centric architecture is capable of extensive realtime effects processing through a single-slot 64-bit PCI card.
- Uncompressed SD 601 PAL/NTSC over serial digital (SMPTE 259M) with embedded audio or component analog and balanced XLR connections.
- Uncompressed HD and embedded audio over serial digital HD (SMPTE 292M), including all major formats and frame rates such as 1080i, 1080/24p, and 720p.
- DV FireWire (IEEE 1394) input/output over the Mac G4’s built-in FireWire ports. Compressed DV footage can be mixed on the timeline with uncompressed SD footage.
- Simple upgradeability. Start with a SD system, upgrade to HD at any time with an external break-out-box connection that can be installed by the user. Software upgrades extend functionality and feature set.
- CinéOffline offers selectable lower-resolution modes with reduced data rates, for more flexible offline/online workflows in both SD and HD.
- Combination of resolution independent capabilities of the TARGA Ciné engine and the TARGA Ciné software codecs enables CinéWave users to implement flexible, cost-effective workflows, including use of specialized service bureaus and networked workstations for either SD or HD.

1. YC_rC_b is commonly (through incorrectly) referred to as YUV, primarily for the convenience of pronouncing it. For the purposes of this document we will refer to YC_rC_b as YUV.

- Very clean workflow for encoding of digital media for distribution into a variety of QuickTime codecs, with the quality advantage of mastering for distribution from the full uncompressed source.
- Accurate machine control using the included Stealth serial port card with Final Cut Pro. Batch capture and EDL with timecode supported.
- Compatibility and interoperability with a rich set of professional creative tools for QuickTime production on the Power Mac G4, such as Adobe After Effects, Adobe PhotoShop and Adobe Premiere, Alias/Wavefront Maya 3D (under OS X) and Discreet Combustion*.

THE MEMORY-CENTRIC ADVANTAGE

The heart of CinéWave is a powerful memory-centric architecture combining the TARGA Ciné engine (hardware) and the TARGA Ciné QuickTime codec (software); both developed by Pinnacle especially for the Apple Power Mac G4 and QuickTime. The CinéWave architecture is superior to competitive products because of the flexibility, scalability and extensibility it offers, and the outstanding image quality and video processing power it delivers at a very attractive price point.

Memory-centric architecture is a new way of processing video, much closer to a standard computer CPU than to the traditional video switchers of the past. Traditional “Stream-centric” architectures are composed of video processors connected by pipes. Each processor has a fixed function; each pipe can only transmit a fixed video format, and the interconnections between processors are relatively fixed.

In a memory-centric architecture, images are stored in a large memory (up to 128MB in the case of the TARGA Ciné), and a “video CPU” (Pinnacle’s own HUB3 chip) takes these images, performs operations, and then puts them back into the shared memory. This offers a number of advantages over traditional video techniques:

- The image format is not fixed. HUB-3 can work with any image size, small and large, SD and HD, interlace and progressive, 4:3 and 16:9. It can also work with both YUV and RGB, 4:2:2 and 4:4:4 or even 4:4:4:4 with embedded alpha key, with 8, 10 and 16 bits per component.
- The codec format is not fixed. Uncompressed and compressed media can co-exist in the same system. As a practical matter, some operations are best performed in RGB, some in YUV. Traditional architectures only support processing in one format or the other. With the HUB-3 these all become application choices.
- The rendering speed is scalable to suit the image format and codec used. A memory-centric architecture is not fixed to a particular video timing or frame rate. Many simple operations can be performed much faster than real-time. More complex operations, or operations on higher resolution formats may not be achievable in real-time, but they still benefit from substantial acceleration. This is also sometimes called “graceful degradation” in performance. In the case of a stream-centric architecture, complex operations typically hit a real-time “wall” and then simply cannot be processed at all.
- The routing is not fixed. Any operation can follow any other operation. It is merely a matter of programming, just as in a computer.
- The performance of the system will scale with improvements in chip technology. A memory-centric architecture can naturally take advantage of increases in chip speeds and memory densities with essentially the same software.

CinéWave Bandwidth

It has been said that beauty is in the eye of the beholder. Certainly this can be also said about image quality, since subjective viewing is the only real test of image quality. While image quality is ultimately determined by a variety of factors, one of the most fundamental considerations is the overall bandwidth available. Generally speaking the higher the available bandwidth, the higher the potential image quality. But like all good things in life, bandwidth typically “costs” and is in limited supply, leading to various trade-offs that can be made to conserve bandwidth while maximizing perceivable image quality within a given bandwidth budget. Even so, it remains true that the total bandwidth (throughput) establishes the fundamental limit on the image quality and functionality of a system.

The bandwidth of a CinéWave system is extremely high with extraordinary capabilities at every level. Internally, the TARGA Ciné engine has a 128 MB frame buffer on board, closely coupled with the HUB-3 video processor. The HUB-3 can access this 128 MB buffer at an aggregate bandwidth of 1500 MB/sec. The HUB-3 itself can process up to 200 Mpixels/sec. using two parallel processing blocks within the chip. Acting as its own 64-bit PCI controller, the HUB-3 can perform DMA transfers between the TARGA Ciné’s on-board memory and the G4’s system memory at nearly 200 MB/sec. Using a SCSI Ultra 160 disk controller and an 8-way striped disk array with fast disk mechanisms, the TARGA Ciné engine can sustain read/write over the G4’s PCI bus in excess of 150 MB/sec.

In terms of external input/output bandwidth, the TARGA Ciné engine can support a single SD video output stream at 270 Mbps via SDI or component analog, or two SD video output streams using both Digital Tether ports, or an HD video output stream at 1.485 Gbps via HD-SDI, or one HD output stream and one SD output stream simultaneously. The same formats are supported as input streams, though only one input can be captured at one time. No other commercially available system can offer this level of flexibility or this level of aggregate I/O bandwidth at even twice the price.

Because CinéWave supports such high bandwidth at every point in its architecture, the practical limit on image quality for most video production and post-production jobs will be determined by the quality of the camera master, itself limited to the recording bandwidth of the particular tape format used. CinéWave’s uncompressed capture and playback capabilities mean that quality is not lost in the transfer from videotape to CinéWave. But almost every video tape format implements trade-offs needed to reduce the bandwidth of the video signal to better fit within the electro-mechanical constraints of a working VTR. To flexibly accommodate these practical trade-offs, CinéWave offers users an exceptionally wide range of encoding and processing choices.

PROGRAMMABLE PIXEL RESOLUTIONS

The pixel resolution of a particular video format is a key factor in setting the bandwidth requirements, together with scanning method, frame rate, sampling structure, color encoding and bit depth. Bandwidth allocation and frame buffer size per frame will vary significantly as the number of pixels (spatial resolution) is increased or decreased. CinéWave v1.0 supported so-called 601 resolutions for NTSC and PAL. CinéWave v1.1 adds support for three additional ATSC HD resolutions. Programmable control of horizontal and video pixel resolutions, and thus programmable control of frame aspect ratios, are fundamental advantages of this architecture.

PIXEL RESOLUTIONS BY FORMAT

Format	Horizontal Resolution	Vertical Resolution	Aspect Ratio
ITU-R. 601 (525i)	720	486	4 x 3
ITU-R. 601 (625i)	720	576	4 x 3
ATSC 720p	1280	720	16 x 9
ATSC 1080i	1920	1080	16 x 9
ATSC 1080p	1920	1080	16 x 9

PROGRAMMABLE FRAME RATES

Bandwidth allocation will also vary depending on the frame rate. Programmable control of frame rates is another fundamental advantage of CinéWave. Pixel resolution multiplied by the frame rate yields the base number of megapixels per second.

FRAME RATES BY FORMAT

Format	Horiz. Resolution	Vert. Resolution	Mpixels/Frame	Frame Rate	Mpixels/Sec.
ITU-R. 601 (525i)	720	486	0.35	29.97	10.5
ITU-R. 601 (625i)	720	572	0.41	25	10.3
ATSC 720p	1280	720	0.92	60, 59.94	55.2
ATSC 1080i	1920	1080	2.1	30, 29.97, or 25	63.0, 52.5
ATSC 1080p	1920	1080	2.1	24, 23.98	50.4

CinéWave implements I/O for 1080p/24 using the Progressive Segmented Frame (PsF) transport standard. I/O for 1080i/30 can also be accomplished using PsF per user selection.

TARGA Ciné hardware generates precise video clocks and the system is genlockable to an externally supplied analog reference sync input with the Pro Analog Option or serial digital video input with the Pro Digital Option or Pro HD Digital Option. In addition, TARGA Ciné can internally generate its own reference clock for “locking” all the system components to a single timebase.

INTERLACE AND PROGRESSIVE SCANNING

Since the inception of modern video, the technology of raster scanning—the horizontal sweep of an electron beam on image pick-up and image display—has been a fundamental concept. Commonly, video raster scanning is interlaced, whereby all the odd scan lines alternate in sequence with the even scan lines. These alternate groups are called *video fields*, each of which has half the resolution of the full video frame. But the field display rate is twice the frame display rate, producing much smoother-looking motion without wide-area flicker, even when viewing in strong ambient light, without increasing the bandwidth. Put another way, for a given display update rate, interlace scanning requires only 50% of the bandwidth of a progressive (whole image) scanning format. Interlace scanning is a very effective technique, used for many years in both analog and digital video. It takes good advantage of the fact that people cannot see image details (spatial resolution) as clearly when the images are moving. There are drawbacks to interlace scanning, but the overall image quality and viewer experience of interlaced video has been generally acceptable throughout the history of television to date.

Progressive scanning, used in film and computer displays for many years, has been long understood to yield better absolute image quality than interlace scanning, especially when displaying text or detailed graphical images. But progressive scanning comes at a cost of twice the bandwidth for the same frame rate. In the past, progressively scanned video was simply not feasible given the bandwidth available on common video tape formats. This is, however, rapidly changing, with the advent of higher speed digital recording formats that can support progressive scanning, such as the new 1080p/24 and 720p/60 HD formats. Professional digital still photography image formats and computer graphics/animation formats all use progressive—that is, non-interlaced—images.

The TARGA Ciné engine and the TARGA Ciné codecs are designed to operate on either interlaced or progressively scanned images. Progressive images can be “interlaced” in real time via the HUB-3 as they are displayed. Interlaced images can be “deinterlaced” using the CinéWave application software.

COLOR SPACE ALTERNATIVES

There are several different ways to describe color, known as color spaces. There are many color spaces in use in the world today, and the issues of color modeling and computation are subtle. For the purposes of understanding CinéWave, the standard color spaces are RGB and YUV.

In RGB color space, combining Red, Green, and Blue in different ratios makes up all colors. If you have 0% RGB, you get black. If you have 100% RGB, you get pure white. In the figure below, the color image on the left is broken out into its red, green, and blue components and a corresponding histogram¹ for each. In the histogram, the ratio of values that make up a component is plotted—the far left represents pixels with no red, and the far right represents full value red, for example.

RGB COLOR CHANNELS

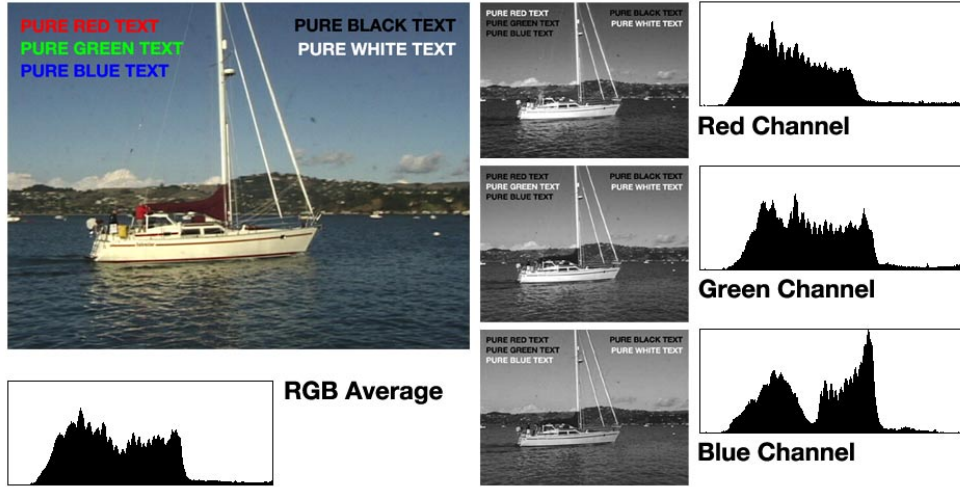

Notice that the text “Pure Red Text” appears as pure black in the Green and Blue images, but pure white in the Red image. This is because the text has the full amount of red possible, and the least amount of blue and green. In these component images, lack of color appears as black and full color appears as white, with gray values in between representing increasingly more of that color component.

In YUV Color Space, the luminance (similar to brightness) of the image is isolated from the color information. Psycho-perceptual studies have shown that the human brain perceives images largely based on their luminance value, and only secondarily based on their color information. Consider the two images below; the first shows only the luminance information of an image, the second only its chrominance (color) information. Which is more recognizable as the boat image?

LUMINANCE AND CHROMINANCE OF AN IMAGE

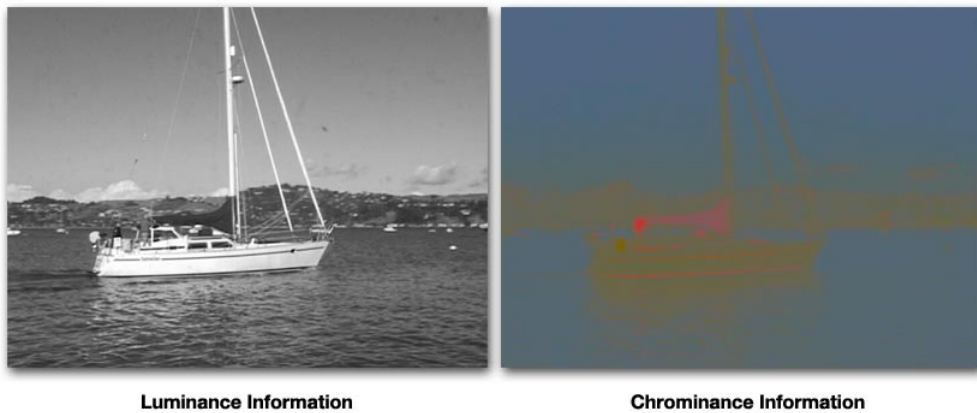

1. A histogram is a graphical representation of the number of pixels in the current frame or channel that are at a specific level of intensity. 0% pixels are at the left and 100% pixels are at the right.

Separating the natural light color spectrum into three channels of Red Green and Blue yields the best color fidelity and visual richness. Virtually all video originates as a full bandwidth RGB signal in either a camera or telecine. Modern professional video cameras use three color filters and three image sensors, one each for R, G and B. Professional video displays use precisely formulated RGB phosphors to convert color video signals (electrical signals) back into color light signals (photons at various wavelengths) that our eyes can see.

However, it is common practice to utilize derivative color spaces that encode video images at reduced bandwidth to fit within the capacity (bandwidth) of commercially available video tape recorders and transmission systems. YUV, (Y, R-Y, B-Y) and the older YIQ commonly used in television equipment are derivative color spaces of the type known as *color difference encoding*. Color difference encoding can save 33% of recording or transmission bandwidth at the expense of spatial resolution in the color components, but it really got its start in broadcast television as a clever trick to add color to black and white television and preserve backwards compatibility for color transmissions viewed on monochrome receivers. As such, YUV is the native color space of certain classes of video tape recording and video transmission devices, not the native color space of video (or physical reality) *per se*.

With the advent of digital video recorders, a new standard emerged, so-called “601” for encoding video according to the recommendation of the ITU Radiocommunication Assembly, last revised in 1994, officially known as *Recommendation ITU-R BT.601-4 Encoding Parameters of Digital Television for Studios*.

The 601 recommendation is designed to ensure interoperability between equipment used for the digital recording, manipulation and/or transmission of NTSC (525i/60) and PAL (625i/50) video signals. 601 defines an extensible family of compatible digital coding standards with recommendations for appropriate application of each. These are specified with a suffix of 4:2:2 or 4:4:4. which refers to the sampling ratio of luminance and chrominance values relative to the spatial sampling of pixels. For example, in the case of YUV encoding for a digital VTR—more correctly written as YC_rC_b —the nomenclature 4:2:2 means that for each 4 luminance samples in the image (the ‘Y’ component), there are two color samples, “ C_r ” and “ C_b ”. The result of this “sub-sampling” of the color components of the image is a reduction in the color resolution from the original image, in this case to one half the resolution of the luminance. This results in a data rate reduction of approximately 33% compared to a full 4:4:4 encoding where every pixel is sampled for luminance and both color values.

RGB color space is typically encoded using 8 bits per component for a total of 24 bits (3 bytes) per pixel. YUV color space is typically encoded using 8 bits per pixel for Y and, effectively 4 bits per pixel for U and V (to reflect 4:2:2 sampling), for a total of 16 bits (2 bytes) per pixel.

This trade-off of bandwidth for color resolution is feasible because the human eye is less sensitive to color detail than luminance detail, especially in motion sequences. However, this does not negate the fact that 24-bit RGB 4:4:4 encoding has greater chroma resolution than 16-bit YUV 4:2:2 color.

Specifically, as illustrated in the table below, the recommendation suggests a 4:4:4 family member in both YC_rC_b and RGB format and a 4:2:2 YC_rC_b family member. The 4:2:2 family members are recommended “for the standard digital interface between main studio equipment and for international program exchange.” The 4:4:4 family members are of higher quality (and higher bandwidth) recommended “for use in television source equipment and high quality video signal processing.”

RECOMMENDATION ITU-R BT.601-4

Family Member	Application	Y/G	C_r/R	C_b/B
4.4.4 RGB	Television source equipment, high quality signal processing	720	720	720
4.4.4 YC_rC_b		720	720	720
4.2.2 YC_rC_b	Standard digital interface, international program exchange	720	360	360

The CinéWave SD options conform to all of the ITU-R BT.601-4 recommendations for signal coding, number of samples per line, sampling structure, sampling frequency, form of coding, duration of active line, and signal level mapping.

In the years subsequent to the definition of 601, newer video formats have been developed using even more aggressive bandwidth reduction schemes that sub-sample chrominance even more. For example, the popular DV format uses 4:1:1 sampling in NTSC countries and 4:2:0 sampling in PAL countries. Again, these sampling formats trade-off reduced chroma resolution for reduced bandwidth without degrading visual quality unacceptably. CinéWave is flexible enough to work smoothly using these popular video formats, as well.

While all these video formats deliver excellent price/performance, the use of chrominance sub-sampling intrinsically reduces color resolution. It dulls the sharpness of edges and can lead to horizontal smearing of color elements. In post production, certain processes such as chromakeying or alpha compositing can suffer noticeably due to this reduced color resolution. Iterative processes using these lower sampling rates can exhibit image degradation over multiple generations.

Pinnacle Systems has found that an architecture capable of only YUV 4:1:1 or even 4:2:2 is inherently limiting and therefore designed the TARGA Ciné engine to be flexible enough to be able to process RGB as well as YUV, to work with 4:1:1, (4:2:0), 4:2:2 and 4:4:4 signals. Ideally, the native pixel representations in both the video and computer graphic worlds must be fully supported in terms of color space, sampling structure, pixel aspect ratio, gamma correction, and quantization levels.

In addition, the TARGA is capable of lossless bi-directional translation of 601 YUV video levels to RGB levels, and back. ITU-R BT.601-4 describes the coding range for an 8-bit YUV digital system with black at a value of 16 and white at 235. To convert to the RGB range expected by virtually all QuickTime application programs today, black must be redefined at a digital value of 0 and white should be set on the value 255. However, in fact, some video signals are consciously created with “super blacks” and “super whites” that fall below the minimum YUV value of 16 and above the maximum YUV value of 235, respectively. In order to convert between YUV and RGB without losing these “super black” and “super white” values, it is necessary to enable so-called “negative RGB values”. To this end, the TARGA Ciné codec will support RGB encoding with either a more data-efficient 8 bits per channel, or a more precise 16 bits per channel, of which 14 bits carry color values and 2 bits carry sign information. The TARGA Ciné engine itself contains dedicated hardware capable of performing matrix multiplications at 13 bits of mathematical precision and LUT operations with 14 bits of interpolated mathematical precision for very high quality color conversion in real time.

What is the difference between the two color spaces? All things being equal there would be no difference whatsoever in how the images appear to the eye. If full bandwidth YUV and RGB images with the same 4:4:4 sampling structures are compared, the size of the files is identical, the color is the same, and there is no loss due to color space conversion if the mathematics are done with high enough precision.

But YUV and RGB are not used in the same way as a practical matter. RGB is usually used with 24 bits allocated to describe each pixel. YUV is usually used with only 16 bits allocated to describe each pixel, due to the 4:2:2 sampling that is implemented in YUV, compared to the 4:4:4 sampling in RGB. In CinéWave, RGB is expanded to support an embedded alpha

key, so sampling is really RGBA 4:4:4:4, 8 bits per component, for a total of 32 bits per pixel. As a result the RGB data rate is greater than the YUV data rate—the RGB file will be bigger, have more data, and maintain more resolution.

In post-production applications, RGB is preferable to YUV in most cases because the image processing and effects performed by computers typically takes place in RGB space. Today, every QuickTime application that does any rendering operations performs those operations (computationally) in uncompressed RGB space sampling 4:4:4:4 with 8 bits per component per pixel.

CinéWave users will most often be working with materials captured from digital VTRs and camcorders *encoded YUV* in combination with images and animations created on the computer using graphics and video elements *encoded RGB*. So we must consider that the workflow is going to be the driving concern on how best to use the different color spaces to preserve the highest quality possible; and that different users faced with different requirements of budget, schedule and client needs may want to choose different workflows. The CinéWave advantage is to be able of flexibly handling both YUV and RGB data at various bit depths and sampling structures; and, moreover, to be able to transparently convert between YUV and RGB with very high mathematical precision for excellent color fidelity.

Typically, video (both SD and HD) will be captured into CinéWave via the TARGA Ciné engine using one of its Digital Tether peripherals in YUV color space, since that is the native color space on the video tape. For cuts-only editing, it is most efficient to simply keep using the YUV encoding throughout. However, using the TARGA Ciné QuickTime codec, it is possible to select the encoding of captured video into either YUV with 8 or 16 bits per component or RGB with 8 bits per component. So, depending on which encoding is selected, a CinéWave disk can hold either (actually both) YUV and/or RGB files. And HUB-3 can process both.

DIGITAL VIDEO BANDWIDTH

Again, because CinéWave supports such high bandwidth at every point in its architecture, the practical limit on image quality for most video production and post-production jobs will be determined by the quality of the camera master, itself limited to the recording bandwidth of the particular tape format used. CinéWave's uncompressed capture/playback capabilities mean that no quality is lost in the transfer from videotape to CinéWave. But almost every video tape format implements trade-offs that reduce the bandwidth of the video signal to better fit within the electro-mechanical constraints of a working VTR.

There are many misunderstandings and fallacies regarding the true nature of so-called “uncompressed” and “digital mastering” video formats. As we can see in the table below, the “most uncompressed” digital video with the greatest base bandwidth is generated in the computer itself when video images are manipulated in full 4:4:4 space, typically encoded in RGB color space. All of the commercial VTR formats use interlace scanning, and/or use chrominance sub-sampling, and/or apply some form of overall signal compression, usually via a combination of DCT algorithms and entropy encoding implemented as M-JPEG, DV, MPEG2, or similar codecs, all to reduce the baseband signal to fit within the practical limits of VTR recording bandwidth.

DIGITAL VIDEO BANDWIDTH

	Format	Color Encoding	Chroma Ratio	Bit Depth	Compression Ratio	Bitstream Data Rate (in Mbits/sec.)
SD Formats YUV	D5	YUV	4:2:2	10	1:1	235
	D1	YUV	4:2:2	8	1:1	167
	DigiBetacam	YUV	4:2:2	8	2.3:1	93 ^a
	Betacam IMX	YUV	4:2:2	8	3.3:1	50
	DVCPPro 50	YUV	4:2:2	8	3.3:1	50
	DVCPPro 25	YUV	4:1:1	8	5:1	25
	DVCam	YUV	4:1:1 ^b	8	5:1	25
MiniDV	YUV	4:1:1 ^c	8	5:1	25	
Mac Apps RGB	Commotion Pro	RGB	4:4:4	8	1:1	252
	Final Cut Pro	RGB	4:4:4	8	1:1	252
	After Effects	RGB	4:4:4	8	1:1	252
	Photoshop	RGB	4:4:4	8	1:1	252
	Maya 3D	RGB	4:4:4	8	1:1	252

- a. DigiBeta transports a 10-bit signal, but is internally only 8-bit. Therefore, the real resolution is 8-bits.
- b. PAL DVCam is 4:2:0 chroma.
- c. PAL Mini DV is 4:2:0 chroma.

DIGITAL VIDEO SAMPLING

All professional VTRs for standard definition (SD) video formats record most, if not all, of the full spatial (luminance) sampling of the 601 digital video standard. Color values are sampled at half the frequency as luminance, so-called 4:2:2. To reduce bandwidth further for more portable devices using smaller videotape cassettes, chrominance is further under-sampled at 4:1:1 (or 4:2:0). And image compression is also applied using DCT-based algorithms such as M-JPEG, DV (and its variants) or MPEG2 (and its variants).

Video tape recording of HD is a much bigger technical challenge due to the higher resolution and higher data rates required. Only the D6 and D5 HD studio recorders preserve the full 1920 x 1080 pixel resolution and 4:2:2 YUV sampling structure of the 1080 standard formats. But even the D5 HD recorder applies an M-JPEG like codec to reduce the bandwidth to within its recordable data rate.

In order to enable portable production (rather than just studio production), HD formats running on smaller, lighter mechanisms are needed. As a practical matter, this has meant reducing the data rate further. The portable HD formats, Sony's HDCam and Panasonic's DVCPPro HD, both of which are "1080 capable", actually sub-sample spatially using sophisticated filtering to effectively reduce the recorded luminance resolution from 1920 x 1080 set forth in the standard specification to 1440 x 1080 or 1280 x 1080, respectively, with commensurate reduction in chroma resolution per scan line. HDCam appears to have a higher spatial resolution than DVCPRO HD does, but DVCPPro HD appears to have a higher chroma resolution than HDCam. One format is not necessarily "better" than the other.

The particular parameters of each of these VTR formats will vary according to their design, but they all try to balance the many trade-offs possible for reducing the bandwidth recorded to tape while preserving image quality to the maximum extent within the bandwidth budget of a given tape format. And the fact is, despite all these trade-offs, the subjective image quality off all these formats is outstanding. And CinéWave can handle them all

DIGITAL VIDEO SAMPLING

Format	Luminance Samples	Chrominance Samples
<i>601 NTSC Format</i> ^a	720x486	360x486
CinéWave 601	720x486	360x486
D1	720x486	360x486
Digital Betacam	720x486	360x486
Betacam IMX	720x486	360x486
Digital S	720x486	360x486
DVCPPro 4:2:2	720x486	360x486
DVCPPro	704x480	176x480
DVCam	704x480	176x480
DV	704x480	176x480
<i>1080 ATSC Format</i>	1920x1080	960x1080
CinéWave 1080	1920x1080	960x1080
D6	1920x1080	960x1080
D5 HD	1920x1080	960x1080
HDCam	1440x1080	480x1080
DVCPPro HD	1280x1080	640x1080
<i>720p ATSC Format</i>	1280x720	640x720
CinéWave 720p	1280x720	640x720
D5 HD	1280x720	640x720
DVCPPro HD	960x720	480x720

a. Chart assumes 525i (NTSC) sampling for 601 formats.

Quality Theory Applied in a Real-World Workflow

Now that we've explored the true nature of digital video formats as used in real world digital VTRs, we are ready to explore the issue of quality during workflow using a CinéWave System. Obviously it is desirable to preserve every bit of data possible when bringing material into the CinéWave system, but it is even more important to understand how the data stream will degrade in quality as it moves through the post-production pipeline.

Let's consider the pipeline that an image may go through as it is captured to a CinéWave system. Over the Pro Digital Option, the input is a serial digital SMPTE 259M signal; over Pro Digital HD Option the input is SMPTE 292M.

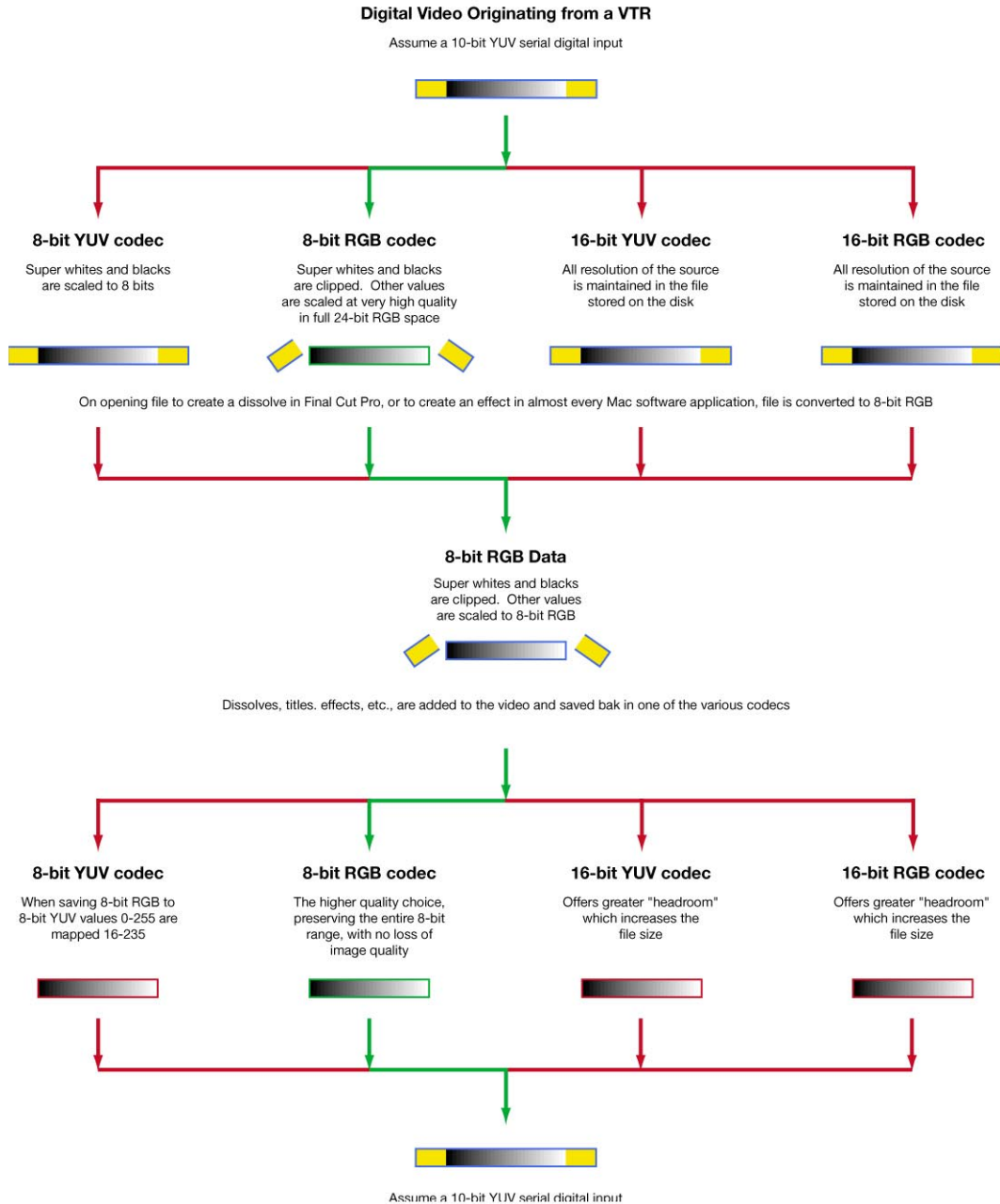

As the figure illustrates, there are distinct advantages to using the TARGA Ciné RGB codec for desktop editing and effects regardless of whether your VTR source is SD or HD, YUV 8-bit or 10-bit. This is because Mac-based QuickTime graphics applications commonly use an 8-bit RGB color space for image processing and rendering of all types. This includes Com-motion Pro, Final Cut Pro, PhotoShop, After Effects, Combustion* and Maya 3D. Rendering can include operations as simple as a cross dissolve or title super-impose, and as complicated as a multi-layer composite with moving elements. Rendering is typically done in RGB space, regardless of the format of the captured video. That is, if the video on disk is encoded YUV 4:2:2, it must be converted to RGB 4:4:4 for rendering. If a system only supports a YUV codec, then the output from the RGB rendering pipeline must be re-converted back to YUV every time it is stored to disk or passed back to the video card. This can mean multiple color conversion steps required to process most video effects. Many of these color space conversions can be saved if the video is encoded directly to RGB upon capture, or if intermediate results of rendering can be preserved in RGB color space within the computer until making a single, final conversion to YUV just before output as a video signal for transmission or recording to video tape.

The ability to implement a TARGA Ciné 16-bit YUV (or even a 16-bit RGB codec) allows CinéWave to handle video and graphics with higher bit-depth per component for increased dynamic range. In this way, CinéWave can support YUV 10 bit (as found on the D5 VTR) or even higher quality RGB 12-bit files generated by advanced film scanners when application software evolves to handle these higher bandwidth formats. It is already clear, though, that in complex post production processes the ability to store intermediate results in these higher bit depths is particularly advantageous because it allows any subtle errors or “mathematical noise” to be accumulated in the least significant bit(s) of the file format and then discarded upon final output without degrading the final image, even when outputting to VTR like the D5, D5 HD or D6, which are capable of recording a YUV 10-bit signal.

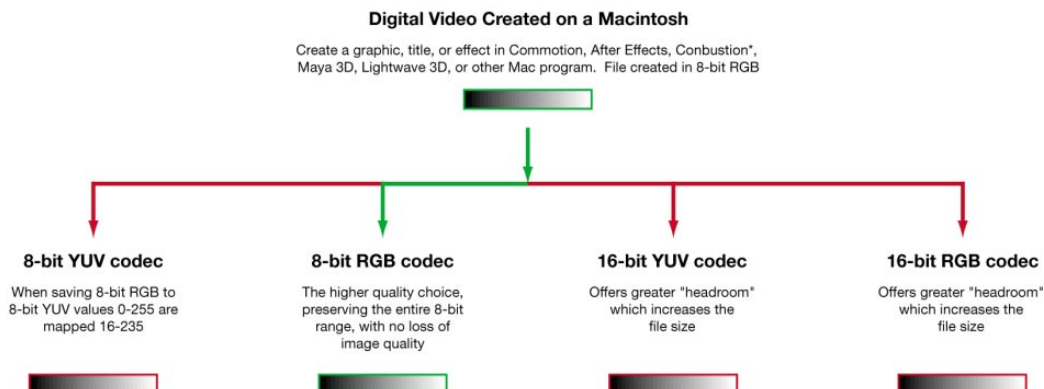

Whether you use CinéWave's YUV or RGB codecs, in either 8 or 16 bits per component, when CinéWave is playing back a sequence of clips to video, all color space conversion is done on the fly at very high precision by the TARGA Ciné's onboard HUB-3 video CPU. For motion graphics work, the TARGA Ciné RGBA codec is recommended as the highest quality option available. When digitizing materials from video devices, users can chose on a case by case basis to save disk space by using the YUV codec, or if they prefer to maintain the highest quality possible on the desktop, they can transcode to YUV 16-bit, RGBA 8-bit or RGBA 16-bit.

10-BIT VERSUS 8-BIT

10-bit vs. 8-bit is a commonly misunderstood issue. 10 is more than 8 so 10 must be better, right? For that matter, Ciné-Wave offers 16-bits—even better, right? Not necessarily. As we have shown, the native color space of digital video in 99% of applications is really 8-bit YUV. Only the Phillips D6, and the more common Panasonic D5 are actually capable of recording 10-bit YUV to tape. So 10-bit YUV is not necessarily the “best” way of preserving the “true” resolution of source materials.

Most digital video workstations for the Mac only offer 8-bit YUV QuickTime codecs, and as such, a 10-bit YUV codec would be a significant improvement over an 8-bit YUV codec when rendering an After Effects project or a Maya 3D animation, for example. But as we've already explained, the real color space of Commotion Pro, Final Cut Pro, After Effects, Photoshop, Combustion*, and Maya 3D today is 8-bit RGB. Therefore in real world production, an 8-bit RGBA is often preferred.

CinéWave is alone amongst all Mac digital video solutions in offering both YUV and RGB codecs, in either 8- or 16-bits. These QuickTime codecs are interchangeable and can be mixed and matched together in a project. This is a unique CinéWave advantage. And it is possible because Pinnacle's proprietary HUB-3 video CPU, the heart of the TARGA Ciné engine, implements a memory-centric architecture designed from the start to support very high quality video processing with maximum flexibility. Other systems may talk about 10-bit YUV as the highest quality, but they do so only because they are incapable of working at higher bit-depths or in RGB space, the native space for all image processing on the Mac.

A special note should be made regarding the SMPTE standards for HD and SD, known as SMPTE 292M for HD and SMPTE 259M for SD. These "serial digital" formats are used to transport the digital bit stream between different digital video devices. These SDI interfaces are designed to carry both 10- and 8-bit signals, with a flag that identifies which of the two is being sent. CinéWave's Pro Digital Option (SD-SDI) and Pro HD-Digital Option (HD-SDI) both support 10-bit or 8-bit signals. But just because a VTR supports 10-bit SDI does not necessarily mean it records 10-bit YUV on tape. For example, Digital Betacam supports 10-bit SDI input/output, and is therefore Digital Betacam is commonly thought to be a 10-bit format. It is not. DigiBeta is an 8-bit YUV 4:2:2 format with moderate DCT compression that translates the 8-bit resolution on tape to 10-bit for transport on serial digital. This translation process does not add additional "quality" to the signal. Likewise, 10-bit serial digital signals sent to a DigiBeta VTR will be reduced to 8-bit YUV within the VTR prior to compression and recording to tape.

TARGA Ciné QuickTime Codec

CinéWave's QuickTime codec is called the TARGA Ciné codec and is typically controlled from within the QuickTime compression settings dialog. With the release of v1.2, the TARGA Ciné codec will offer the following choices:

- TARGA Ciné YUV 8 or 16-bits per component
- TARGA Ciné RGB 8 or 16-bits per component

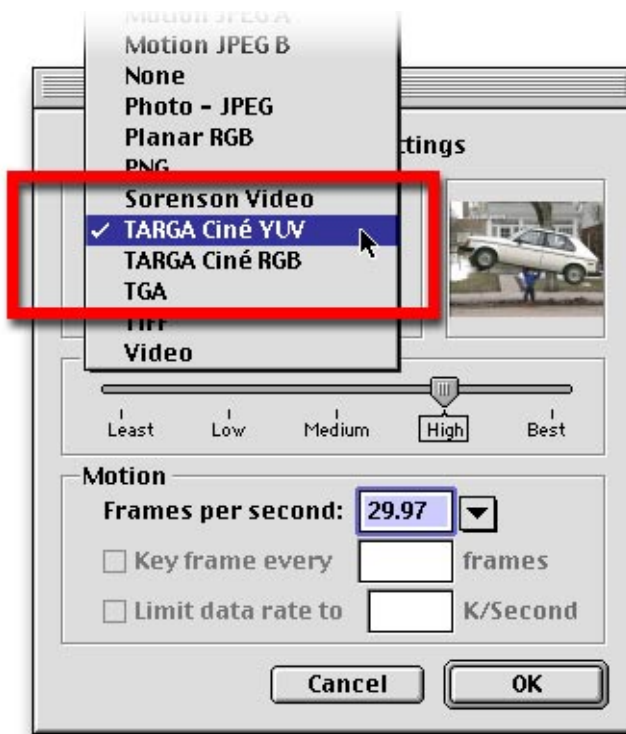

Unlike other digital video systems, CinéWave can operate in either YUV or RGB. This yields higher quality and a more flexible workflow for the user who can opt between either 8 or 16-bits per component in either color space, choosing 4:2:2 sampling for YUV or 4:4:4 sampling for RGBA.

The choice of codecs for color space encoding and various bit-depths impacts overall bandwidth used. The table below illustrates data rates for 1080 and 720 images at various frame rates, along with NTSC and PAL rates for comparison. Both YUV and RGB data rates are listed, in both 8- and 16-bits per channel. In the case of SD, the data rates are well within reach of a standard CinéWave system equipped with the appropriate disk array. Users can choose to work in either 8 or 16-bits, YUV or RGB.

As we can see, the data rates for HD formats in either 16-bit YUV or RGB are quite large, so 8-bit YUV HD is the only codec for HD that is practical today for realtime capture/playback. But for internal rendering, YUV-16 and RGB-8 (or even RGB-16) can be used to great advantage for those needing the highest image quality—another CinéWave advantage.

CINÉWAVE DATA RATES ^A

Format	KB/frame	MB/sec.	GB/min.	GB/Hour	KB/frame	MB/sec.	GB/min.	GB/Hour
	8-bit YUV 4:2:2				16-bit YUV 4:2:2			
601 NTSC	684	20	1.2	70.0	1367	40	2.3	141
601 PAL	810	20	1.2	70.0	1620	40	2.3	139
1080i/30	4050	119	7.0	417	8100	237 ^b	13.9	834
1080i/25	4050	99	5.8	348	8100	198	11.6	695
1080p/24	4050	95	5.6	334	8100	190	11.1	697
720p/60	1800	105	6.2	371	3600	211	12.4	742
	8-bit RGBA 4:4:4:4				16-bit RGBA 4:4:4:4			
601 NTSC	1367	40	1.9	141	2734	80	4.7	282
601 PAL	1620	40	1.9	139	3240	79	4.6	278
1080i/30	8100	237	11.2	834	16200	475	27.8	1669
1080i/25	8100	198	9.3	695	16200	396	23.2	1390
1080p/24	8100	190	9.0	667	16200	380	22.2	1335
720p/60	3600	211	10.0	742	7200	422	24.7	1483

- a. Data rates are for video only, and don't include audio data. Frame sizes round off to best size for DMA efficiency.
 b. Figures in red exceed the capacity of current known systems. Realtime full motion playback not possible, but frame-by-frame operations are feasible.

When loading material into the Mac the user can choose whether to capture the digital video as either YUV or RGB. Once the material is on the computer, it will be a standard QuickTime movie which can be opened and played back in any QuickTime application, including Final Cut Pro, Commotion Pro, After Effects, etc. If you are creating a clip from within a software application, you must choose one of the TARGA Ciné codecs as your codec type. In doing so, the clip you render will be a CinéWave format clip, and as such it will play back in any QuickTime native application.

One of the most impressive demonstrations of the power of CinéWave's QuickTime native codec is to simply double click on any of the CinéWave clips, opening the movie in Apple's MoviePlayer application. When you hit "play" the window will display full resolution images at full speed while the video ports simultaneously display both SD and HD video streams (if both SD & HD are connected).

EMBEDDED ALPHA CHANNELS

The TARGA Ciné RGBA codec can be set to Millions+, allowing for a 32-bit (8-bits per channel) or a 64-bit (16-bits per channel) RGBA file to be created with an embedded alpha (the "A" of RGBA) channel, 4:4:4:4. This feature allows graphics programs such as character generators (for titling), 3D animation packages, and motion graphics and special effects programs to save an alpha channel together with the video clip. The most practical use for this alpha channel will be for realtime compositing using CinéWave's realtime capabilities. (The TARGA Ciné YUV codec does not support an embedded alpha channel at this time.)

PREVIEWING WITH CINÉWAVE FROM WITHIN SOFTWARE APPLICATIONS

One of the critical workflow issues when doing motion graphics and effects work using a computer based system is the need to preview images during the interactive creative process. CinéWave's QuickTime components allow many Mac applications that support QuickTime to preview work "on the fly" to the CinéWave monitors, including SD video, HD video and the G4's high resolution VGA desktop display, as well.

Final Cut Pro and Commotion Pro (both included with CinéWave) can be set to preview all effects work prior to rendering by setting up a preference to use the TARGA Ciné's outputs as preview codecs. Discreet has also announced that Combustion* will soon support QuickTime previews as well.

Echo Fire is a third party plug-in available for Adobe After Effects and Photoshop which will enable both applications to preview to CinéWave and other QuickTime outputs (such as FireWire). For more information, visit <http://www.echofire.com>.

UNCOMPRESSED CODEC FOR BEST QUALITY

Regardless of which CinéWave codec the user chooses, the benefits of uncompressed workflow will have a dramatic impact on the quality of the images produced when compared to results from a compressed system.

Compressed video systems that rely on DV, M-JPEG or even MPEG 2 compression can suffer from a phenomenon called iterative compression artifacts. Iterative compression is the process of rendering and re-rendering into the compressed format, with each generation further degrading the image quality, much like analog video loses quality with successive recording generations (even though the causes of the degradation is different in the analog case.) Iterative compression artifacts do not appear when simply viewing first generation playback of video shot in a camera. However, each of the following events will trigger iterative compression of the image:

- Load footage from tape
- Add any effect to the image (such as a dissolve)
- Add any title to the image (or any graphic super-impose)
- Change the speed of the video image (slow-motion effect)

As each of these events takes place on the non-linear timeline a second, third, or fourth compression can take place on the image, each of which can introduce new artifacts and reduce the overall image quality. Complex post-production processes with many "layers" can require many iterative compression "generations", with unwanted image degradation as a result.

The following charts illustrate the detrimental effect of iterative compression using DV and M-JPEG codecs. Ten (10) generations of compression are applied to an image. The original image appears in the upper left, labeled "Generation 0." It is a completely uncompressed image. As the image is compressed with the DV or M-JPEG codec the image detail starts to degrade rapidly, showing dramatic loss of quality by the tenth generation. To help clarify the image deterioration (which may be hard to see if you are reading a printed version of this document) a difference matte accompanies each image. In the difference matte, pure black indicates pixels that are identical to the original Generation 0 image, while gray and white pixels indicate an increasing shift in value as the image deteriorates.

DV 5:1 Compression Codec

As can be seen in the image below, the DV codec rapidly decays in quality beginning immediately with the first generation of iterative compression. If a user simply adds a dissolve or a title to any DV footage this level of degradation will be introduced and image quality will suffer as a result. By the tenth generation the image has suffered such severe degradation that it is most likely not suitable for any application.

DV COMPRESSION

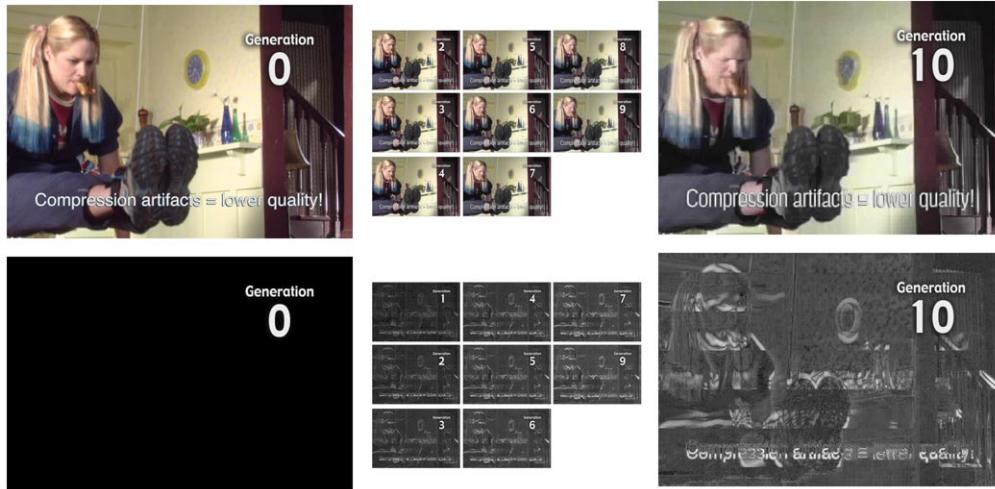

M-JPEG 2:1 Compression Codec

The degradation of the M-JPEG image is somewhat less noticeable when looking at the color image, but the difference matte reveals the increasing loss of quality. In this particular example, a very high quality M-JPEG pass was applied, only compressing the image by about 2:1. If a greater level of compression were used the artifacts would be more dramatic and the resulting quality would be even lower.

M-JPEG COMPRESSION

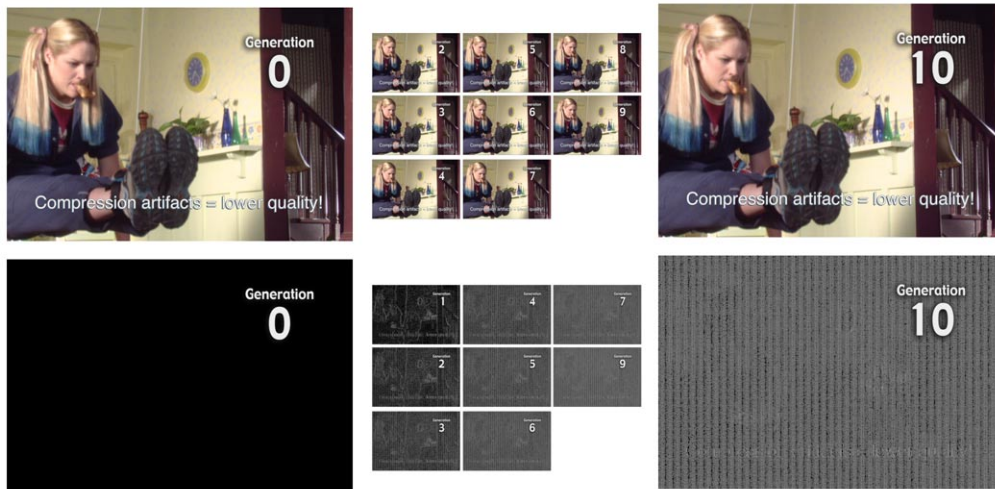

TARGA Ciné 1:1 Uncompressed Codec

With the TARGA Ciné codec we can see the benefit of uncompressed post-production. There no perceivable degradation in the color image, and a look at the difference matte shows 100% fidelity to the original Generation 0 image, with no change in any pixels value even across 10 generations of recompressing the image. In this example, the TARGA Ciné RGB codec was used, providing a 100% pure uncompressed pipeline. Even if a YUV codec were used (8- or 16-bits), the image quality would still be vastly superior to the M-JPEG and DV compression results.

TARGA CINÉ COMPRESSION

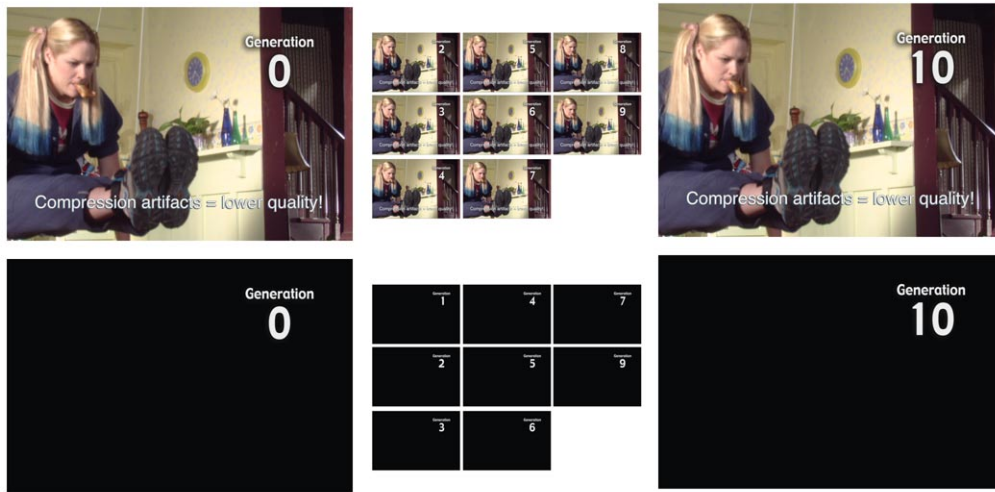

CINÉOFFLINE

While working with uncompressed video has many advantages for the user concerned with producing at the highest possible quality, it has one major drawback: high bandwidth that can fill up disk capacity quickly. CinéWave's new CinéOffline mode, (to be implemented in v1.2, scheduled for Winter 2001) reduces the storage requirement for SD & HD source material so that it is possible to load more minutes of footage onto a given system for an offline edit.

It is not uncommon for video and film projects to have a high ratio of source material to finish program length, anywhere from 20:1 to 100:1 depending on the project. Hard disk drives are always increasing in storage capacity and dropping in price, so over the long term disk drive capacity and price/performance is trending in the right direction. But in the short term, a system will often not have enough storage to load all the source material desired at full resolution for a editing session. This is less of a problem for motion graphics design and effects work, where the total durations are short(er). But for long form editing, it is axiomatic that there is never enough disk space, whatever the video format used.

CinéOffline allows the user to specify a lower resolution at which to store the incoming video using the HUB-3 advanced realtime image scaling capabilities. For example, a 1080i HD frame is nominally 1920 x 1080, but with CinéOffline the user can choose to down-res the image "on the fly" during capture to 1/2, 1/4, or 1/8th of the source resolution. This will yield 4x, 16x, or 64x lower data rates, respectively. And commensurately greater storage capacity in terms of minutes available on a given disk configuration. With CinéOffline, system that only had storage for 1 hour of HD footage at full resolution can potentially accommodate up to 64 hours of CinéOffline material at lower resolution. CinéOffline images will appear somewhat "softer" as the scaled down resolution is reduced, but playback will be at full screen size using the TARGA Ciné engine to scale up "on the fly" during playback. Users will need to evaluate different resolutions for their particular footage before choosing the optimum CinéOffline setting for their project.

SAMPLE CINÉOFFLINE DATA RATES ^A

	CinéOffline Resolution	CinéOffline MB/second	CinéOffline GB/minute	CinéOffline GB/hour
601 NTSC	<i>Full Res</i>	20	1	70
	<i>High Res</i>	5	0 ^b	19
	<i>Medium Res</i>	1	0	4
	<i>Low Res</i>	0	0	1
1080p/24	<i>Full Res</i>	95	6	334
	<i>High Res</i>	24	1	83
	<i>Medium Res</i>	6	0	21
	<i>Low Res</i>	1	0	5
720p/60	<i>Full Res</i>	105	6	371
	<i>High Res</i>	26	2	93
	<i>Medium Res</i>	7	0	23
	<i>Low Res</i>	2	0	6
1080i/30	<i>Full Res</i>	119	7	417
	<i>High Res</i>	30	2	104
	<i>Medium Res</i>	7	0	26
	<i>Low Res</i>	2	0	7

a. All formats encoded with 8 bit YUV 4:2:2 Uncompressed Codec. Data rates are for video only, and do not include audio data. All data rates are approximate.

b. Zero indicates total of less than one (1) full unit (i.e. < 1 GB/min.)

The example below illustrates how CinéOffline can be used. On capture, the 1080 image is reduced in size to 1/4 of its resolution, thereby maximizing disk storage by 16x. During editing, the image is automatically scaled-up to full screen so that the editor can watch a full size image on the video monitors, visually duplicating the final/online production (except for the softer

image quality). Once the edit is completed, a batch digitize can be performed using the original source footage to capture just the segments of the footage to be used in the final program at full uncompressed resolution.

This offline/online workflow, all done without compression *per se*, makes CinéOffline exceptionally useful for long form editing of both uncompressed SD & HD footage alike.

Also, by selecting a CinéOffline format with lower bit rates, users can share media over relatively “skinny” networks and perform creative work using less powerful systems, including portable PowerBook laptop computers, even if that system doesn’t have a TARGA Ciné engine installed. As long as the TARGA Ciné QuickTime software codec is installed, the CinéOffline images can be accessed and processed, albeit at lower resolution.

SAMPLE CINÉOFFLINE WORKFLOW

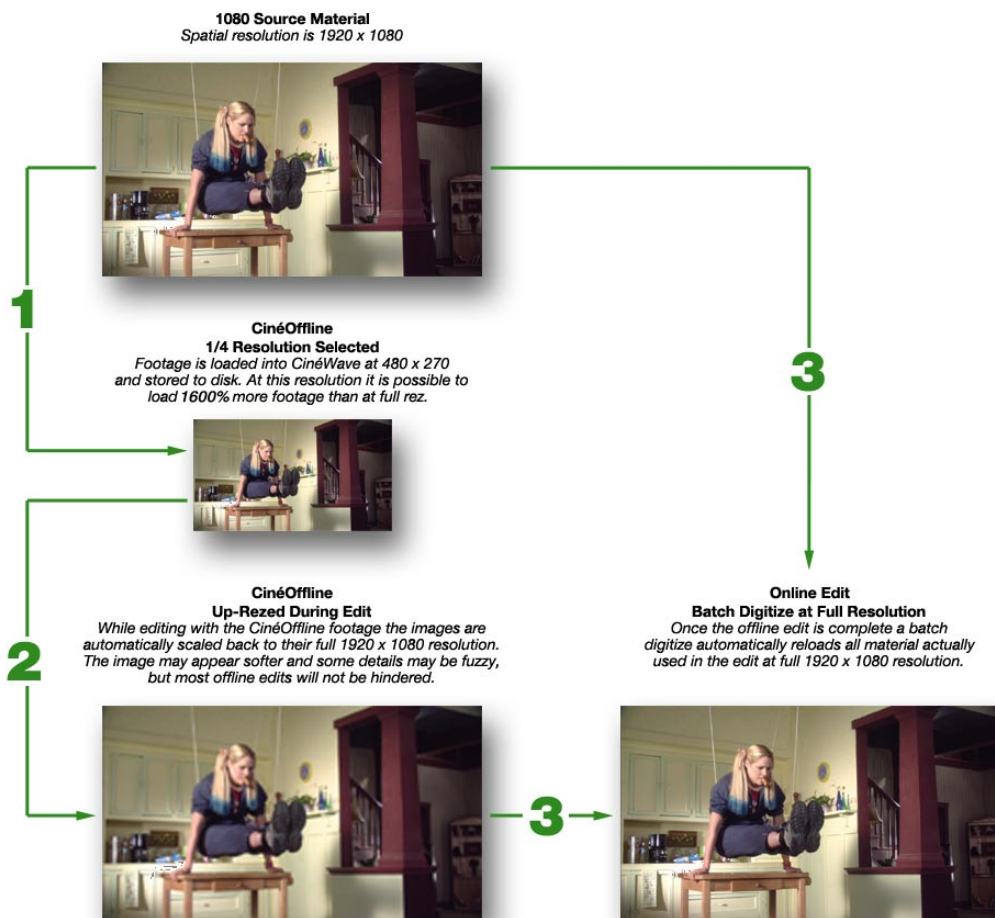

REALTIME EFFECTS WITH CINÉWAVE

Many users ask, “Is CinéWave capable of realtime effects?” The answer is YES! CinéWave will support the new effects architecture of QuickTime 5 and will use the processing power of the TARGA Ciné engine’s HUB-3 to implement a variety of realtime effects under the next generation of QuickTime applications designed for that purpose. It is widely expected that these applications will become available in the Spring of 2001.

The new QuickTime 5 effects architecture fits extremely well with the memory-centric acceleration architecture of Pinnacle's TARGA Ciné engine. Every CinéWave has been designed to support realtime effects through the addition of additional software functionality. Using powerful video processing hardware to accelerate pixel processing, CinéWave systems are capable of processing multiple streams of SD video and graphics with numerous realtime effects. Over time, Pinnacle will add more and more functionality with ongoing software upgrades. CinéWave users will be able to download a new set of drivers for their CinéWave systems from the Pinnacle website which will turn-on the inherent RT capabilities of the TARGA Ciné engine. The exact feature sets to be implemented in realtime and how these RT capabilities are presented to users will depend on the particular application software used.

In fact, CinéWave's first level of realtime processing has already been implemented in version 1.1 of the CinéWave drivers, whereby the TARGA Ciné engine can perform realtime up-conversion of SD (60i) video to HD formats, or realtime down-conversion of HD formats to SD video, with appropriate letterbox and posterbox masking inserted automatically to accommodate the different frame aspect ratios. Using the same HUB-3 video processor, CinéWave can perform a realtime 3:2 pull-down to play out 24 fps source clips as properly timed 60 field interlace (30 fps) formats including 1080i/60 and 525i/60, with full support for 59.94 clocking as well.

Over time, CinéWave will be capable of more and more complex multi-layer realtime effects at SD resolutions, and accelerated effects processing at HD resolutions. A key factor is the availability of fast, economical disk drives with higher storage densities and greater throughput.

For example, with NTSC/PAL D1 (ITU-R. 601), the baseband data rate is 21 MBps, but approximately 30 MBps disk throughput must be allocated for reliable capture/playback of a single stream of uncompressed SD video using an 8-bit YUV codec 4:2:2. For a two stream dissolve that is sent straight to the Digital Tether for output to a VTR or display, throughput reading from disk must be approximately 60 MBps. If the resultant stream (after the dissolve or composite) is to be rewritten to disk in realtime, then another 30 MBps throughput must be reliably available over the PCI bus to write to the disk simultaneously to the 60 MBps reads, for an aggregate throughput of 90 MBps.

Pinnacle has confirmed that SCSI Ultra 160 disk controllers from ATTO and Adaptec can fully support the throughputs necessary for realtime effects with standard definition video using available disk mechanisms from a several leading disk drive manufacturers. For further details please consult your local CinéWave dealer or the Pinnacle website at <http://www.pinnaclesys.com>.

The same principles apply for working with HD materials, just at much higher bandwidths. While the various HD formats have different bit rates, they all require many times more than SD video. 1080p/24 runs at approximately 100 MBps; 720p/60 needs about 110 MBps; and 1080i/30 takes roughly 125 MBps. Per single stream uncompressed full resolution 8-bit YUV 4:2:2. Again, actual disk throughput must allow adequate headroom above the baseband data rate. Pinnacle recommends the use of external disk arrays with a tested read/write speed of at least 150MBps to ensure reliable HD capture/playback in all formats.

HD CinéWave requires a very high performance configuration. Actual disk read/write speeds can vary depending on specific devices and device drivers used and must be properly installed. However, Pinnacle has found that it is practical to configure a single SCSI Ultra 160 PCI controller card with at least an 8-disk striped array using 10,000 rpm (or faster) devices to sustain the requisite 150 MBps throughput. If the newest 72 GB disk devices are used, the resultant 8-disk array can hold roughly half a Terabyte, equivalent to approximately 75 to 90 minutes of HD storage, depending on which HD format is used. Using a maximum of 12 x 72 GB devices per SCSI Ultra 160 channel, with two channels per controller card, it is feasible with today's commercial off the shelf technology to store between 3.5 to nearly 5 hours of uncompressed HD contents depending on the format used. For further details please consult your local CinéWave dealer or the Pinnacle website at <http://www.pinnaclesys.com>.

The bandwidth needed for just one stream of HD approaches the practical limit of even today's fastest 64-bit PCI busses and high performance disk drives. A system capable of realtime dissolves between two HD streams would require sustained throughput of nearly 300 MBps. This level of throughput is not feasible with today's technology, making it fundamentally impossible to implement multiple stream realtime effects for HD on a CinéWave (or any other similar system).

However, the HUB-3 video processor on the TARGA Ciné engine can still be used to significantly accelerate rendering speeds for HD effects, even while recognizing that HD formats have roughly 5-6 times the number of pixels to process per frame compared to SD formats. More complex HD effects will need to be rendered using the G4 under such applications as Final Cut Pro and Commotion Pro. Both applications are multi-processor aware and optimized for the G4 Velocity Engine, greatly speeding up host-based rendering of effects at any and all resolutions.

Digital Tether

CinéWave supports a unique interconnection technology called Digital Tether that allows the system to connect to different digital and analog video and audio peripherals. On the back of the TARGA Ciné Engine there are two Digital Tether ports that can be simultaneously connected to any of CinéWave's optional breakout boxes.

Pro Analog Option

The Pro Analog Option provides input and output to composite, component, and s-video, as well as balanced and unbalanced stereo audio.



Pro Digital Option

The Pro Digital Option provides serial digital input and output of SMPTE 259M video with or without embedded audio. A single serial digital connection to a D1, D5, DigiBetacam, DVCPRO 422, Digital-S, or other properly configured SDI-ready VTR will carry both video and embedded audio to the system using a single BNC cable.



Pro Digital & Analog Option

The Pro Digital & Analog Option provides the functionality of both the Digital and Analog Options, and adds SPDIF and AES/EBU audio input/output. This option will be available in 2001.



Pro Digital HD Option

The Pro Digital HD Option provides serial digital input and output of SMPTE 292M video and embedded audio. A single HD-SDI connection to a D5 HD, D6, HDCAM, DVCPRO HD or other properly configured HD VTR will carry both video and audio to the system using a single BNC cable.



REALTIME SIMULTANEOUS SD & HD OUTPUT

TARGA CINÉ ENGINE

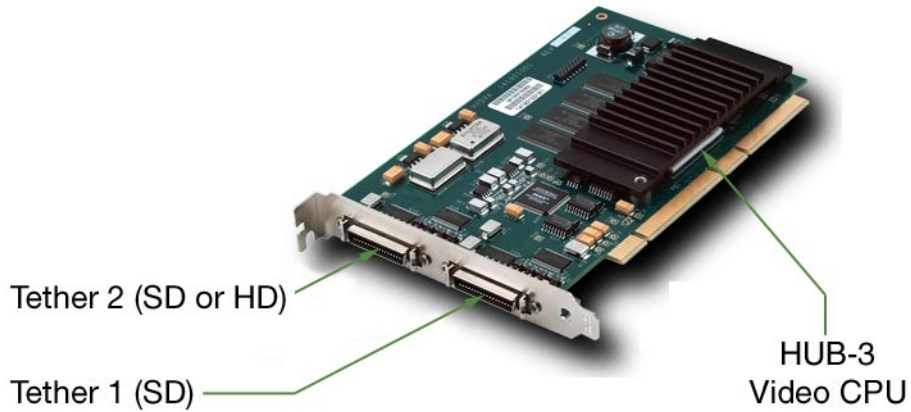

CinéWave's two Digital Tether ports are simultaneously active at all times. For working in SD formats, the two ports could be used to connect both SDI and analog VTR to the same CinéWave system, for example. If both a SD and HD option are connected to the TARGA Ciné Engine using the two Digital Tether ports simultaneously, all images being processed by the system will be output in parallel to both SD and HD formats. This allows the user to output multi-format SD/HD in one pass, greatly increasing productivity and enabling very flexible HD/SD workflows.

SAMPLE CINÉWAVE SYSTEM CONFIGURATION

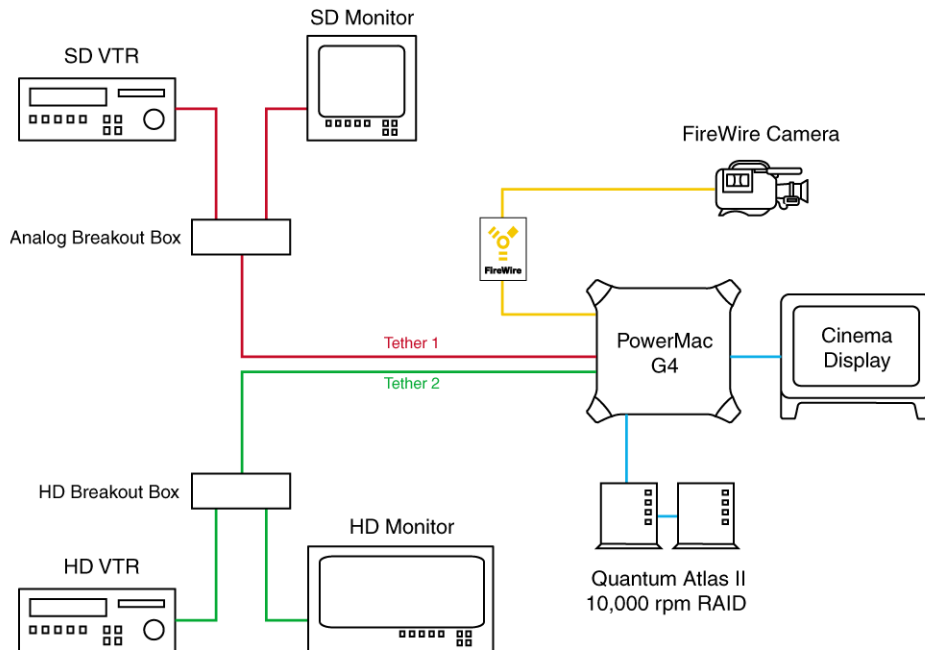

This multi-format simultaneous output capability works regardless of whether the source material is SD or HD. CinéWave v1.1 with the TARGA Ciné engine can perform realtime up-conversion of SD (601) video to HD formats, or realtime down-conversion of HD formats to SD video, with appropriate letter box and posterbox masking inserted automatically to accommodate the different frame aspect ratios. Using the same HUB-3 video processor, CinéWave can perform a realtime 3:2 pull-down to play out 24 fps source clips as properly timed 60 field interlace (30 fps) formats including HD 1080i/60 and SD 525i/60, with full support for 59.94 clocking, as well.

SAMPLE CINÉWAVE FORMAT CONVERSIONS

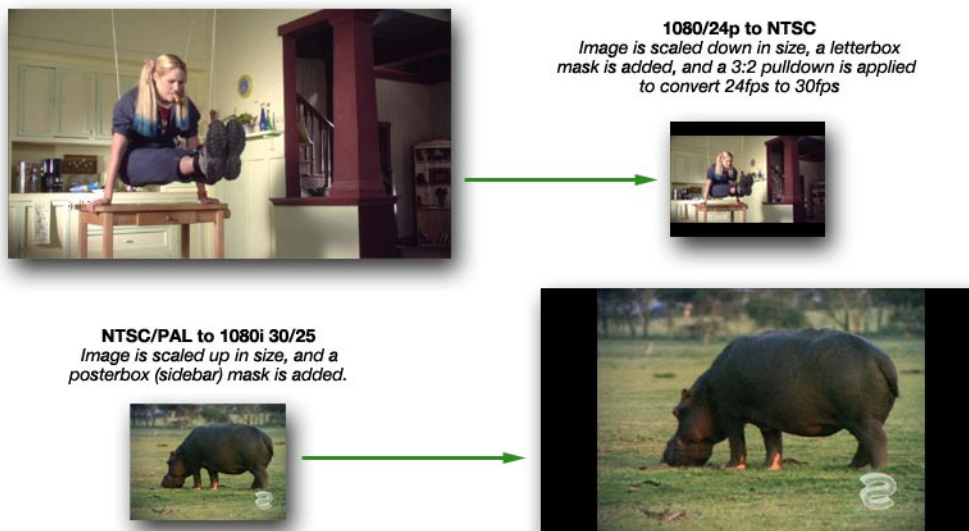

CINÉWAVE WORKGROUPS

CinéWave has been designed to accommodate the needs of the many creative professionals who collaborate in workgroups, especially those who have been wanting to work with HD but have held back due to the high price of entry. First, the CinéWave HD systems are very economical themselves, priced well below traditional HD editing and post-production solutions from traditional vendors. Second, CinéWave has been designed to allow a CinéWave workgroup to leverage one Pro HD Option attached to one CinéWave station to handle the HD I/O for an entire group of CinéWave stations. All members of the workgroup can share HD clips over a network or through disk swapping among CinéWave stations. A CinéWave Pro Analog configuration which can only capture/playback using SD video devices can still perform HD editing or effects work using a standard SD video monitor!¹

Users with multiple workstations can move files between systems that have the CinéWave hardware and those that do not. The CinéWave extension needs to be installed to enable a Power Mac G4 to read and write TARGA Ciné QuickTime files. Simply copy this extension into the System folder of any Mac, and that system will be able to both read and write files to the TARGA Ciné codec formats. This is a critical feature that allows a workgroup to collaborate on projects without the need for multiple installations of the full CinéWave hardware. Render graphics on a PowerBook, for example, then simply copy them over a network to your G4 CinéWave system to play them back at full speed and output to a VTR.

Another model for CinéWave HD production is to go to an outside post house or service bureau which has a full HD video equipment installation for the capture/playback to HD video devices. After batch loading of the HD footage onto a user's CinéWave disks, the user can then carry those HD contents back "home" to work on using a SD system. Then when the cre-

1. The drives must be fast enough to play back HD footage, however.

ative work is complete and its time to output the finished product to an HD VTR and watch it on an HD display, the user can go back to the post house or service bureau for another “HD session.”

For many potential users, the big upside of the CinéWave approach is that HD production becomes feasible without actually making enormous up-front capital investments in the HD video gear, special workstations or new application software. The only significant down-side of these workflows is that the user can not preview their video program or associated motion graphics and effects at full HD resolutions without at least an HD-capable display and the Pro HD Digital Option attached to CinéWave. Despite these drawbacks, this model will appeal to many productions that are comfortable working at a SD offline resolution and finishing their projects at a CinéWave-equipped HD post house or HD service bureau.

CINÉWAVE OUTSOURCED POST-PRODUCTION WORKFLOW

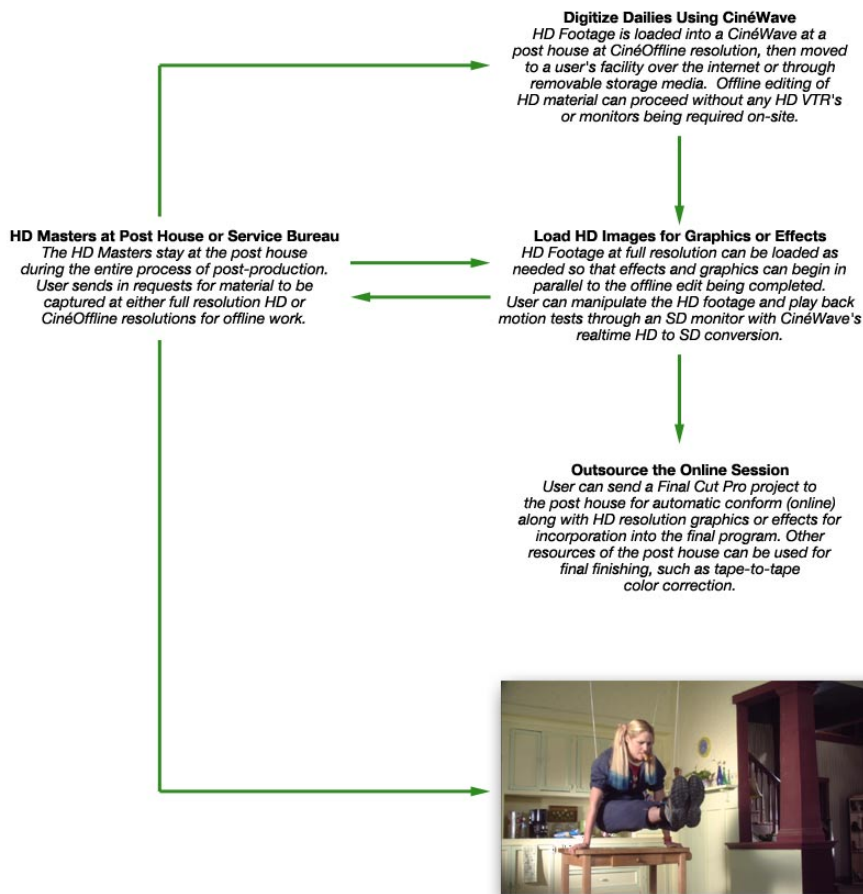

SD TODAY, HD TOMORROW

Because of its inherent HD capabilities, the upgrade from an SD CinéWave System to a full HD system can be performed in the field by the user who must simply connect the Pro Digital HD Option to the back of the TARGA Ciné engine using the second Digital Tether port. Of course, disk drive performance may also need to be upgraded, as all HD systems require at least 150 MB/sec. of disk throughput. Since most users will want to take advantage of the realtime capabilities of CinéWave at SD resolutions, we expect that most CinéWave systems will already be equipped with the necessary disk sub-systems, making the HD upgrade literally a 15 minute process.

CinéWave is unique in this flexible approach to SD and HD. Users can invest today in CinéWave knowing that they can complete HD projects using the outsource technique described above. When a project comes along to justify bringing the full

HD production in-house, CinéWave users can upgrade their existing system and workflow in a matter of minutes. There is no need to change application software or system hardware to complete the upgrade.

This level of flexibility for working with HD footage opens up new production opportunities for anyone who has considered working with HD but has been scared off by the huge capital investment that would have been required with any other solution besides Pinnacle's CinéWave.

Once source material is captured onto a CinéWave system, various application programs can be used to edit and design motion graphics. However, CinéWave systems can also be made to behave as if they are a DDR. Using third-party software a Mac can be made to slave itself to serial control signals received from other devices. By using QuickTime as the slaving system CinéWave can be made to playback HD and SD images under control of external devices. Information on using CinéWave in this manner can be obtained from <http://www.demon.co.uk/gallery/frameIDX.html>.

HD in Use Today

There are several emerging markets for HD video today which show tremendous potential. Most users have been hearing about HD for many years now (most of the last decade), but HD's slow adoption as a broadcast medium has confused many and raised questions about the viability of HD in the future

TRADITIONAL USES FOR HD

The most logical use for HD television is of course broadcast programming. Many countries including the US, Japan, Australia, and Korea, have already begun broadcasting significant amounts of content in DTV formats (or plan to phase-in HD broadcasts significantly in the next few years). DTV includes the 1080 and 720p specs, as well as lower resolution 480p. A portion of the programming being broadcast in HD is actually HD content (i.e. produced in HD), while some of the content is simply SD material that is translated up to HD resolution for broadcast. HD-capable television sets have dropped to the US\$2,000 price range and are available at mass market retailers in the US such as Best Buy, Circuit City, and The Good Guys.

Most television programming falls into one of the following categories: news/studio programming, sports/live events, or dramatic content (movies, sitcoms, or episodic series'). In the United States CBS is producing a large portion of their primetime programming in HD. HBO and Discovery Channel offer HD channels over DirecTV satellite. NBC is broadcasting The Tonight Show with Jay Leno in HD. Large live events such as the US Open™, the SuperBowl™, and the Oscars™ are often simulcast in HD.

A related but separate area for HD use is post-production. The investment in HD post-production today can be partly justified as an investment in the long-term shelf life of the programs. This is akin to what happened to one of television's first hit shows. *I Love Lucy* was produced during the so-called golden age of television, an era when almost all shows were broadcast live. *I Love Lucy*, however, was shot on film. The unexpected by-product of this production technique was that years later *Lucy* was available for syndication and went on to make a killing in recurring revenues, whereas all of its contemporary competitors had no archive of their program. While today's HD programs may not be widely consumed as HD, they will be available in HD ten years from now and may have opportunities for new revenue through syndication in new mediums.

Most television content shown in US primetime is shot on film. In HD post-production the film negative is transferred to HD format, and the editing and effects work is completed in much the same way that traditional SD post production would take place. With CinéWave productions can be edited directly in full HD resolution or—more likely—in a lower resolution offline mode, then conformed to HD when the edit is completed.

Another obvious opportunity for HD programming is the large library of feature films. Since they were shot on traditional film—which is of higher resolution than HD—all feature films are inherently HD-ready. By transferring films to HD a large library of HD content can be built up very quickly. Again we see a parallel with early color television, when feature films were broadcast frequently to take advantage of the new capabilities of the broadcast medium.

EMERGING MARKETS FOR HD

There are many other markets for HD production and post-production that fall outside of the traditional broadcast/home viewer model. One of the most exciting is the emerging concept of Digital Cinema. CinéWave is a particularly well suited system to address this emerging market. (In fact, CinéWave got its name from the “Ciné-ma” concept... the oncoming wave of new production is expected to be a force of creative change in the film industry.)

The advantages of digital film making are numerous, and promise nothing less than to revolutionize the film business by driving down costs and in the process freeing up creative story telling from the traditional financing, production, and distribution practices of the industry. The concept is that a small crew with some high-tech cameras and computers can make movies faster, better, and cheaper. The resulting digital projects can then be distributed not only through traditional theaters,

but also through emerging new channels such as the Internet, micro-cinemas in bars and homes, and on shiny platters such as DVDs.

The primary requirement of digital cinema is an end-to-end digital production pipeline. Film makers can shoot their footage using any quality of digital video camera (from DV all the way up to HD), then edit, color correct, add effects, mix music and sound effects, and master the final program to any medium. CinéWave is uniquely relevant for digital cinema thanks to its support for DV and SD as either PAL or NTSC, as well as all HD resolutions. With a CinéWave system users have all of their production tools for any quality digital film on one integrated system.

Other interesting areas for HD are the art, medical, scientific, and virtual reality markets. SD video has often hampered these applications because of its limited canvas, a small area on which to render the complex data. The higher spatial and temporal resolution of HD images allows for new levels of experience and data visualization. Many simulation rides and special venue presentation where a large image is required can now use HD instead of older technologies such as seamed video walls or film.

Archiving is another application for which HD is ideally suited. By making HD protection masters film content and other image data can be stored at high resolution in a reusable digital format that will be readily available in the future. Users such as NASA will be archiving large catalogs of space imagery to HD, in part to preserve the images for posterity, and in part to make them more readily accessible to the public; it may soon be possible to request a digital viewing of space footage, something that would have been hard to accomplish with the film masters.